

Turbine Starters

ST500 Series

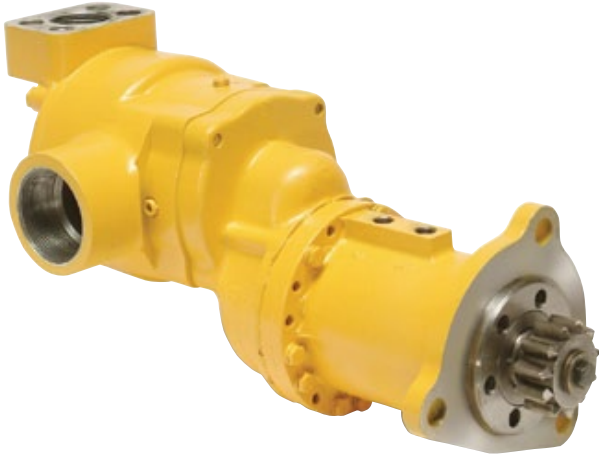

For engine displacement of:

Diesel—500 to 6000 (8 to 100 liters)

Carbureted—1000 to 12,000 CID (16 to 200 liters)

Features/Benefits

- Powerful 44 hp turbine motor uses no external lubrication
- Steel insert at inlet ensures a solid connection
- Smooth pre-engagement piston minimizes ring gear wear
- Sealed, oil-lubricated planetary gears provide maintenance-free operation

Versatile

- Sealed for use in gas and air applications
- For use with air or natural gas
- 4 inlet, 4 exhaust, and 16 drive housing orientations
- Left- or right-hand rotation
- Optional pinions and flanges to fit most engines
- 30-150 psi (2.1-10.3 bars) operation

Industry Applications

MARINE



OIL & GAS



OFF-HIGHWAY



POWER GENERATION



Turbine Starters

Dimensions

Weight: 38 lbs (17.2 kg)

Note: All dimensions shown are for reference only. Specifications subject to change without notice.

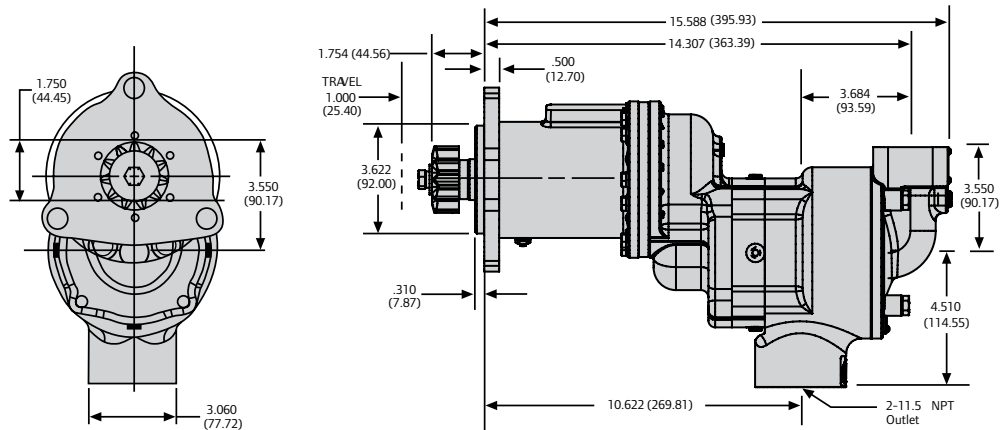

Performance Information

Pressure psi (bar)	Breakaway Torque ft-lb (Nm)	Speed @ Max HP rpm	Max Power hp (kW)	Flow @ Max HP scfm (L/s)
ST544				
60 (4.1)	74 (100)	1296	9 (7)	310 (146)
90 (6.2)	113 (153)	1480	16 (12)	430 (203)
120 (8.3)	147 (200)	1580	22 (17)	600 (284)
150 (10.3)	182 (247)	1620	28 (21)	750 (354)
ST599				
30 (2.1)	72 (98)	1185	8 (6)	340 (160)
60 (4.1)	132 (179)	1500	19 (14)	580 (274)
90 (6.2)	206 (280)	1530	30 (23)	780 (368)
120 (8.3)	247 (336)	1540	36 (46)	1000 (475)
150 (10.3)	295 (400)	1560	44 (58)	1240 (585)





Model Coding



ST544 F 03 R 25 - 0 2 F J



Turbine Starters

Parts and Accessories

Part #	Description
 150BMP-1051B	1/4" 12 V Solenoid Valve
 SMB-G618	Gas Rated Push Button Valve
 SMB-618	Push Button Valve
 SRV125T	1-1/4" Relay Valve for Transit Aftermarket
 SRV125	1-1/4" Relay Valve for Stationary Air
 150BMP-1064	1/8", 150 psi Pressure Gauge
 ST500-A735	2" Road Splash Deflector

Part #	Description
 ST500-K166	SAE J518 Split Flange
 150BMP-1056	1/2" Check Valve
 150T-312	2" Muffler
 SMB-441	Liquid Sealant
 *ST900-267H/150	1-1/2" Strainer Housing
 *ST900-266/150-HP	1-1/2" Strainer (50 microns)

*For complete filter (strainer + housing), please order ref ST900-267/150-HP

Genuine Ingersoll Rand Replacement Kits

Tune Up Kit Part Number	Description
ST500-TK1	ST500 Starter Tune Up Kit
ST500-SK1	ST500 Seal Kit